



# **EVID™** **Ceiling Speaker Systems**

Installation and Operation Manual



Table of Contents . . . . .	ii
Welcome . . . . .	1
Important Features . . . . .	1
Model Summary . . . . .	2
Packing List. . . . .	2
Product Feature Identification. . . . .	3
Installation and Wiring . . . . .	4
Step 1 – Cut the Hole . . . . .	5
Step 2 – Install C-Ring and/or Tile Rails . . . . .	5
Step 3 – Attach Wiring to the Terminal Connector . . . . .	5
Step 4 – Secure the Cable to the Speaker . . . . .	6
Step 5 – Mount the Speaker into the Ceiling. . . . .	7
Step 6 – Connect an Auxiliary Support Line . . . . .	8
Step 7 – Adjust Tap Selector . . . . .	8
Step 8 – Insert the Grille. . . . .	8
Appendix A – Painting the Speaker. . . . .	9
Appendix B – System Design Guide . . . . .	10
Selecting and Positioning Ceiling Loudspeakers. . . . .	10
Ceiling Systems: Size vs. Coverage. . . . .	10
Use of Subwoofers. . . . .	11
Appendix C – Troubleshooting Table . . . . .	12
Appendix D – Warranty . . . . .	13
Exclusions and Limitations . . . . .	13
Appendix E – Product Specifications . . . . .	14

# Welcome/Important Features



## Welcome

Thank you for purchasing EVID™ Ceiling Series loudspeakers. Read through this manual to familiarize yourself with features, applications, and precautions before you use these products.

EVID Ceiling Series loudspeakers use innovative design and materials to provide premium-level performance in a flush-mount ceiling format. Four models comprise the EVID Ceiling Series: the C4.2 with a 4-inch LF driver and a .75-inch, titanium-coated tweeter with waveguide; the C8.2 with an 8-inch LF driver and a 1-inch titanium-coated tweeter with waveguide; the C8.2HC with a fully waveguide-loaded 8-inch LF driver and a 1-inch titanium coated tweeter; and the EVID 10.1, a true ceiling-mounted subwoofer designed to augment and extend the full-range model's low-frequency response.

## Important Features

- Matches acoustically to the EVID surface-mount speaker line
- Model for model, has superior performance to competing brands
- Comes with both 70V/100V or 8-ohm operation standard on every model
- Includes all installation accessories commonly needed for most jobs

## EVID™ C4.2

Perfect for conventional rooms. It has excellent bandwidth in an esthetically very unobtrusive installation profile. Its compact design fits in tight areas. Its 4-inch woofer and waveguide-coupled, titanium-coated dome tweeter give smooth, wide frequency response. The enclosure is ported and tuned to provide surprising bass response in such a compact package. Features an easy 3-point mounting system for quick installations.

## EVID C8.2

The C8.2 has a specially tuned enclosure and 8-inch woofer to provide amazing bass response. The 1-inch waveguide-coupled tweeter give smooth controlled coverage out to 20 kHz. Perfect for installations where a flush-mount design is desired but demand for high-quality audio exists. Features a 4-point mounting system to make installations fast and easy.

## EVID™ C8.2LP

The C8.2LP is the same as the C8.2 but in a low-profile installation package. Ideal for tight ceiling spaces.

## EVID™ C8.2HC

The EVID C8.2HC is ideal for high ceilings and reverberant “problem” rooms. Its exclusive ported, waveguide-coupled, 8-inch driver provides excellent intelligibility and definition. The 8.2HC’s patent-pending design provides great coverage control throughout the voice range and above. No other ceiling speaker system provides the combination of excellent pattern control, wide bandwidth, high power handling, and compact design like the C8.2HC.

## EVID™ C10.1

The C10.1 packs a 10-inch subwoofer in a tuned high performance enclosure to give amazing low frequency performance down to 45Hz! It is one of the few quick-mount ceiling TRUE subwoofers available. Flexible installation and powerful low-end performance make it the ideal mate to any EVID ceiling model.

## Packing List (Figure 1)

Figure	Quantity	Part
A	2	Speaker system
B	4	Tile rails
C	2	C-ring support
D	2	Grille
E	1	Owner's manual
F	4	Support ring screws
G	2	Terminal connector
H	1	Service center card
I	1	Cutout template
J	2	Paint Shield

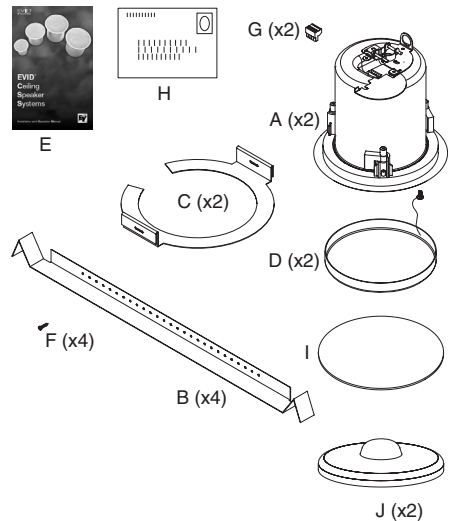


Figure 1: EVID packing list

# Product Feature Identification



## EVID™ Ceiling Series Systems (sold in pairs)

Model	Part No.	Description
C4.2	301258000	4" coaxial speaker with horn-loaded, Ti-coated tweeter
C8.2	301261000	8" coaxial speaker with horn-loaded, Ti-coated tweeter
C8.2LP	301318000	Same as C8.2 above except with low-profile backcan
C8.2HC	301262000	8" waveguide-coupled* coaxial speaker with horn-loaded, Ti-coated tweeter
C10.1	301263000	10" High performance subwoofer

\*Patent pending

## EVID Series Ceiling Mount Speaker Accessories

Model	Part No.	Description
RR-42	301305000	Rough-in plate for new construction involving the EVID C4.2 (package of 4)
RR-82	301306000	Rough-in plate for new construction involving the EVID C8.2 and C8.2LP (package of 4)
RR-810	301307000	Rough-in plate for new construction involving the EVID C8.2HC and C10.1 (package of 4)
RPK-42	301308000	Rough-in package for new construction involving the C4.2 speaker only (package of 2)
RPK-82	301309000	Rough-in package for new construction involving the C8.2 and C8.2LP speaker only (package of 2)
RPK-810	301310000	Rough-in package for new construction involving the C8.2HC and C10.1 speaker only (package of 2)

## Product Feature Identification

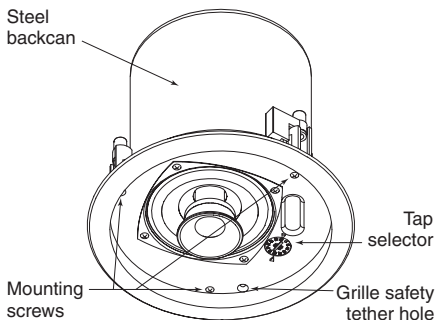


Figure 2: Bottom of speaker

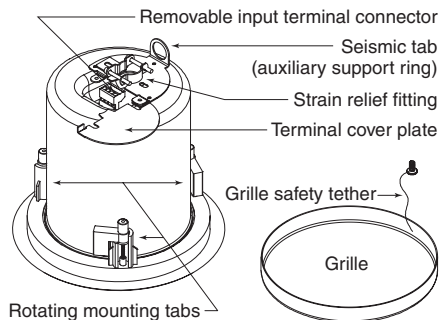


Figure 3: Top of speaker

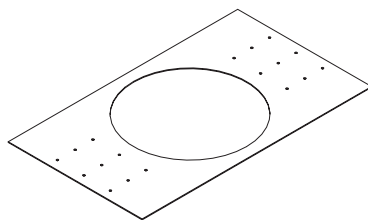
The EVID™ mounting system has been designed so that, if necessary, the installation can be done from beneath the ceiling. In some cases with a suspended ceiling grid, however, it may be easier to access from both the top and bottom of the ceiling tile during the installation process. Typical installation hardware needed for either suspended ceilings or sheetrock ceilings is included. The ceiling speaker assembly is held in place by mounting tabs that securely grip the ceiling material. Input wiring is attached to a removable terminal block connector that can be pre-wired if necessary before speaker installation to speed up the installation process.

### INSTALLATION NOTE: USE OF OPTIONAL ROUGH-IN ACCESSORIES

For most installations, no additional hardware is needed. However, a two-step installation procedure that is sometimes used for installation into sheetrock ceilings can be made easier by the use of the optional RR and RPK series of rough-in accessories before the ceiling material is installed. The rough-in accessories provide a cutout guide when many holes are to be made in a production-line style installation and to ensure the speakers are positioned correctly as the holes are cut in the sheetrock. Depending on the requirements, two types of rough-in accessories are available.

#### RR Series Mounting Plates

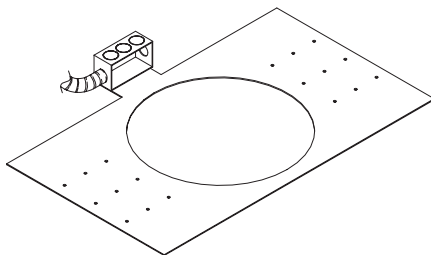
RR series plates are made of flat sheet metal with holes to attach to the joists or trusses of a building structure. The holes are drilled for nails or screws at 16 inches (406 mm), 20 inches (508 mm) and 24 inches (610 mm) on-center. The installer can drill other holes as needed up to a maximum of 24-3/4 inches (630 mm) apart. The sheetrock installs over the plate, and the plate provides a template for a blind cutout of the hole in the sheet rock. The ceiling material is generally cut with a router-type cutting tool, using the plate ring as a cutout guide. The mounting plate is illustrated in Figure 4.



**Figure 4:** Speaker mounting plate

#### RPK Series Kits

The RPK series rough-in kit contains a RR series plate with a standard 2 gang electrical box mounted on the top with an attached short length of flexible conduit which connects to the ceiling speaker conduit clamp on the speaker's rear terminal cover. This accessory allows for rigid conduit to be run to the box on the rough-in plate before the speaker or any sheetrock is installed. After the sheetrock is installed the speaker can be wired up and mounted all from below the ceiling. The RPK mount system is shown in Figure 5.



**Figure 5:** RPK mounting system

### INSTALLATION NOTE: CONTROLLING VIBRATION

Because of their high performance, EVID ceiling loudspeakers can generate substantial vibration, which can cause buzzing in loose sections of the ceiling structure. Depending on the character of the ceiling tile and related components, dampening material may need to be used under the tile rails or the edges of the tiles to eliminate rattles.

## Step 1: Cut the Hole (Figure 6)

For suspended tile or sheetrock ceilings, cut out the hole either by tracing the cardboard template or with a circular cutter set to the appropriate cutout size. If the wire has been pre-installed, pull the wiring through the cutout hole.

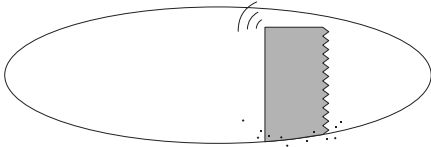


Figure 6: Cut ceiling hole

## Step 2: Install C-Ring and/or Tile Rails (Figure 7)

All EVID speakers come packaged with two types of backing hardware: a C-ring and two tile rails.

For suspended ceiling installations, insert the C-ring through the hole cut in the ceiling tile. Place the C-ring around the hole with the tabs located as shown in Figure 7. Insert the tile rails through the cut hole in the ceiling tile. Snap the two rails into the two tabs in the C-ring and align the rails so that the ends extend OVER the T-channel grid on the side of the tile. Secure the rails onto the C-ring tabs by inserting a screw through each tab into the rail, as shown in Figure 7.

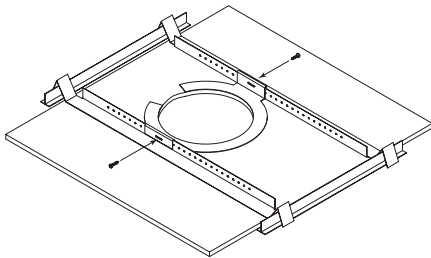


Figure 7: Secure rails to C-Ring

## INSTALLATION NOTE: TILE RAILS AND C-RING

Each speaker comes with two tile rails which are designed to fit either standard 24-inch-wide or 600-mm-wide tiles. It is important to note that the tile rail pieces do not actually attach to the T-grid struts. The ends of the rails sit OVER the T-grid strut. Normally, the tile supports the rails. The tile rails are pre-punched at regular intervals with holes along their length. This allows the C-ring to be positioned at any point along the rail. If the tile comes out or falls apart, the ends of the support rails fall onto the T-grid, which prevents the speaker assembly from falling.

Always use all included support hardware when installing into suspended ceiling tiles to make sure the installation is secure.

For sheetrock ceiling installations, the C-ring should be used by itself to reinforce the ceiling material and to spread out the pressure from the speaker hold-down tabs. Guide the C-ring through the cut hole in the ceiling, and place it on the back side of the hole before inserting the speaker.

## Step 3: Attach Wiring to the Terminal Connector (Figure 8)

Insert the bare end of wire into the appropriate connector terminals as described below and screw down the hold-down screw until tight, using a small screwdriver.

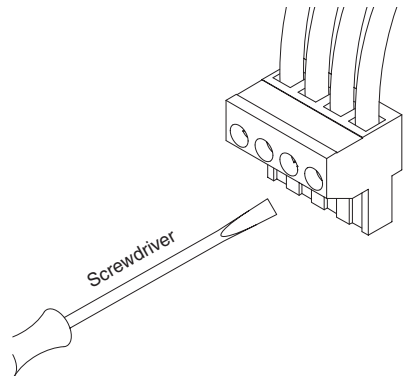


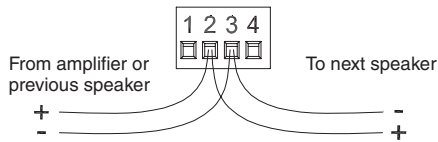
Figure 8: Tighten with screwdriver

## INSTALLATION NOTE: CONNECTOR WIRING GUIDELINES

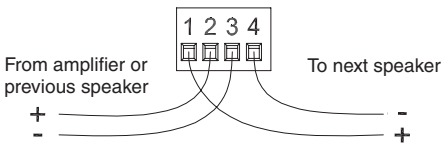
The input connector's 4 terminals are numbered and marked on the connector. Pins 1 and 2 are positive (+); pins 3 and 4 are negative (-). (Pin 1 is connected to Pin 2 and Pin 3 is connected to Pin 4 inside the speaker.) Pins 1 and 4 are used as daisy-chain connections to other loudspeakers. Two possible layouts for wiring a group of speakers are described below.

1. **Wiring in parallel.** Connect the wire pair of the subsequent speaker to pins 2 and 3. When one input connector is removed, subsequent speakers will remain connected. See Figure 9.

2. **Daisy-chaining.** Connect the wire pair of the subsequent speaker to pins 1 and 4. When one input connector is removed, subsequent speakers will also be disconnected. See Figure 10.



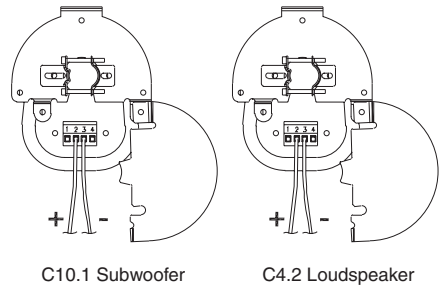
**Figure 9: Parallel wiring**



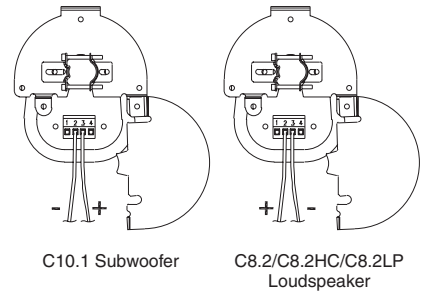
**Figure 10: Daisy-chain wiring**

## INSTALLATION NOTE: SUBWOOFER POLARITY

When adding a subwoofer, be sure to observe the correct polarity. The C10.1 subwoofer has been designed for optimum performance when used with the C4.2. In order to maximize the low frequency output when used with the C8.2, C8.2LP or C8.2HC, the polarity of the C10.1 subwoofer should be reversed. See Figures 11 and 12.

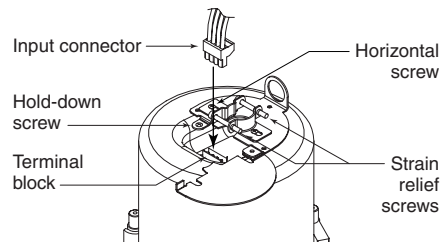


**Figure 11: Subwoofer polarity with C4.2**



**Figure 12: Subwoofer polarity with C8.2/C8.2HC/C8.2LP**

When all wiring has been completed to the connector, plug the connector into the socket in the speaker's terminal cup. See Figure 13. Tighten all screws to eliminate vibration.



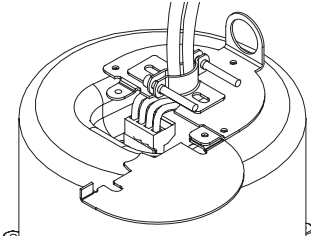
**Figure 13: Plug connector into socket**

## Step 4: Secure the Cable to the Speaker (Figure 14)

Fully loosen the horizontal screw shown in Figure 13, then the strain relief screws. Run the wires through the opening in the fitting and plug the input connector into the speaker's terminal block. Then tighten the strain relief fitting as follows:

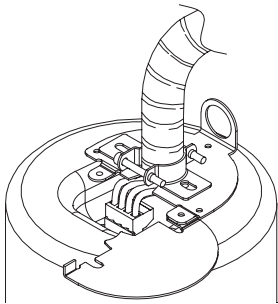


1. If plenum cable is used, slide the wiring through the strain relief fitting on the terminal cover plate (Figure 14). Hold the strain relief fittings tight around the cable. Tighten the strain relief screws first, then the horizontal screw. In the cases of insulated speaker wire and plenum cable, it is often possible to provide acceptable strain relief force by simply tightening the strain relief screws onto the terminal cover plate.



**Figure 14:** Secure cable through fitting

2. If the installation used flexible (BX) or rigid (EMT) conduit, an alternate conduit fitting can be used. See Installation Note and Figure 15 below.



**Figure 15:** Alternate conduit fitting

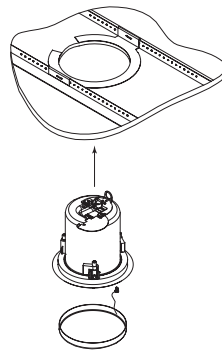
## INSTALLATION NOTE: ALTERNATE CONDUIT FITTINGS

Some cases require alternate fittings, many of which are available through most electrical suppliers. Simply remove the existing fitting by unscrewing the two hold-down screws, exposing a 7/8-inch (22 mm) knockout hole. Then install the alternate fitting. Make sure to always use a listed fitting in accordance with your area's building codes and regulations.

## INSTALLATION NOTE: CEILING TILE CAUTION

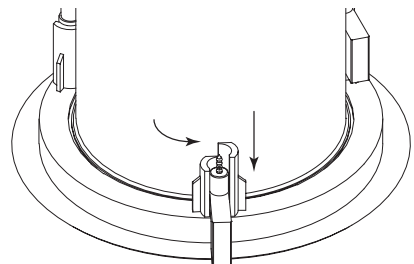
When mounting the units into 2'x2' or 2'x4' suspended ceiling tiles, DO NOT install them in lightweight fibreglass-type tiles without full secondary support for the speaker as noted in Step 6. Such tiles are not designed to support any substantial weight. Speaker installation without secondary support will cause the tile to sag and distort, even with the tile bridge installed. The secondary support line at the rear of the speaker MUST be strung taut in these situations and MUST remove most of the force of the speaker on the tile to ensure that the speaker does not deform the tile.

## Step 5: Mount the Speaker Into the Ceiling (Figure 16)



**Figure 16:** Mount speaker into ceiling

Push the speaker into the ceiling hole until the front baffle rim is flush with the ceiling. Tighten the mounting tabs by turning the screw clockwise until the speaker is secure. Please note that the first clockwise quarter-turn rotates the attachment tabs outward. The remaining turns tighten the tabs down onto the back of the ceiling surface (see Figure 17).



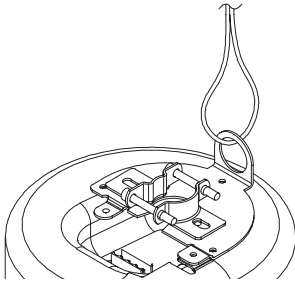
**Figure 17:** Tighten mounting tabs

## INSTALLATION NOTE: MOUNTING TABS

For each attachment screw, first turn one half-turn counterclockwise to release the mounting tab from its guide.

### Step 6: Connect an Auxiliary Support Line (Figure 18)

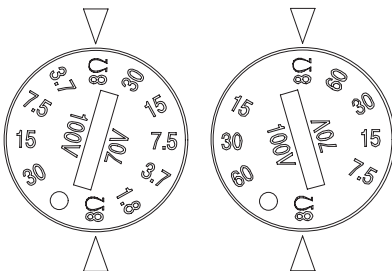
Note the support ring on the back of the speaker. The ring allows for connection to an independent and secure anchor point. Construction codes often require the use of this secondary support point.



**Figure 18:** Attach auxiliary support line

### Step 7: Adjust Tap Selector (Figure 19)

The tap selector switch is located on the front baffle. Adjust the speaker to the appropriate tap setting before installing the grille. In some 70V/100V constant voltage installations it is advisable to leave the grilles off if final speaker audio level balance adjustments are to be made later. After the levels are adjusted the grilles can then be installed.



**Figure 19:** Adjust tap selector (left: C4.2/C8.2/C8.2LP; right: C10.1/C8.2HC)

## EVID™ C4.2, C8.2 and C8.2LP

In addition to the 8-ohm setting, the power taps are 30 W, 15 W, 7.5 W, and 3.7 W at both 70.7V and 100V, with a 1.8 W tap for 70.7V only.

## EVID™ C8.2HC and C10.1

In addition to the 8-ohm setting, the power taps are 60 W, 30 W, and 15 W at both 70.7V and 100V, with a 7.5 W tap for 70.7V only.

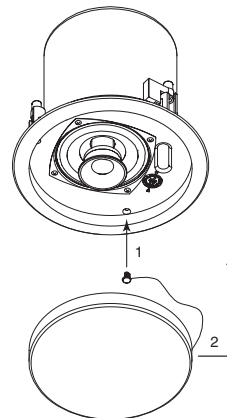
### Step 8: Attach the Grille (Figure 20)

#### INSTALLATION NOTE: GRILLE SAFETY FEATURE

EVID grilles features a unique safety tether to prevent the grille from falling if the grille is removed or comes loose after installation.

First, install the grille's safety tether by pushing the grille fastener into the hole in the front of the baffle (see Figure 20). Second, press the grille into place until the front of the grille is flush with the rim of the baffle. Make sure the grille is securely seated to prevent it from vibrating loose.

If you need to remove the grille, the easiest way is to insert two bent paper clips or other pointed objects into holes in the grille, then apply slow even pressure to pull down on the grille until that section of the grille comes out slightly. Continue the same procedure around the perimeter of the grille, loosening a portion at a time until the grille is removed.



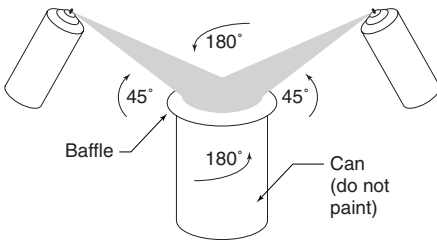
**Figure 20:** Attach the grille

If the speaker is installed in an area where the interior design requires a color match, these speakers are simple to paint. The speakers can accommodate almost any type of latex or oil-based paint. The bezel/rim can be painted before installation or after mounting into the ceiling.

## Painting Process

Clean the rim and grille with mineral spirits or other light solvent. Do not use harsh solvents such as gasoline, kerosene, acetone, or other chemicals. If you use these cleaners you may permanently damage the enclosure. Also, don't use abrasives products such as sandpaper or steel wool.

Either by rolling or spraying, apply two or more thin coats of paint. If you are spraying, hold the spray can at the angles shown in Figure 21.



**Figure 21:** Spray-painting angles

If you are painting the grille also, you must first remove the internal grille cloth. Spray painting is strongly recommended. If the grille is rolled or brush painted, the grille may become clogged with paint and the sound quality will suffer. After the paint has dried, replace the internal grille cloth.

If you wish to paint the speaker along with the ceiling after installation, insert a plastic or cardboard paint shield into the front of the speaker to mask the drivers and internal baffle, paint the speaker, then remove the shield.

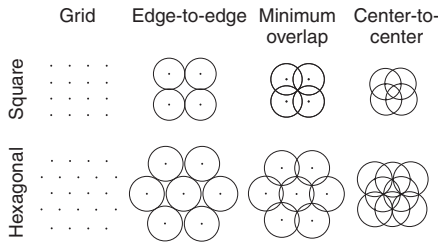
## Selecting and Positioning Ceiling Loudspeakers

Several key criteria determine the type and quantity of ceiling speakers to employ in a job. Specific EVID™ Ceiling Series models accommodate each job, depending on how these criteria are specified.

- Room size
- Coverage density desired
- Coverage angle specification of the speaker
- Ceiling height
- Audio program material being played

The information below, and the free design program downloadable from [www.electro-voice.com](http://www.electro-voice.com) (under downloads/speakers), will help you optimize your EVID design.

In the traditional approach to overhead-distributed systems, loudspeakers are placed in a grid whose dimensions are dictated by the room height and the directivity of the speaker elements. Two basic placement patterns prevail: square spacing and hexagonal (or crisscross) spacing. See Figure 22.



**Figure 22: Coverage patterns**

In addition to the spacing pattern, the designer must choose between three coverage density types, designated respectively as edge-to-edge, minimum overlap and center-to-center. The greater the overlap, the more uniform the coverage. The illustration below shows these various layout patterns.

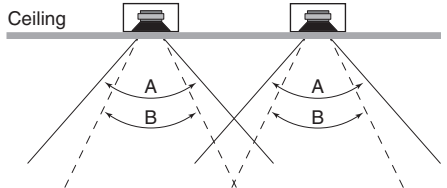
### Ceiling Systems: Size vs. Coverage

In the past, system designers usually specified 8-inch cone loudspeakers for distributed overhead systems, at least in part because they represented the traditional choice. EVID systems,

however, allow for far more flexible options.

In many cases, you can achieve excellent results — at a significant savings — by using 4-inch transducers. This is especially true in jobs that do not require extended low-end response or high SPL levels. 4-inch transducers, such as those used in the C4.2, offer wider dispersion to allow for fewer speakers to be employed in the job. For example, due to its smaller cone diameter, the C4.2 exhibits significantly wider dispersion (130 degrees) than the C8.2 (110 degrees) at the -6 dB points.

The effect of this characteristic on an overhead system is indicated in Figure 23. In replacement applications where existing speaker positions are used, the C4.2 (shown in angle A) offers greater overlap and, thus, more uniform coverage than an older conventional 8-inch unit (shown in angle B). When specifying a new system, you can take advantage of the C4.2's wider dispersion to decrease the number of speakers required to cover a given area. This will result in even greater savings.



**Figure 23: Size vs. coverage**

Of course, the C4.2 is somewhat less sensitive than the 8-inch C8.2. The difference is -5 dB. The C4.2 will also have slightly reduced low-frequency capabilities below 65 Hz. However, neither of these factors is a significant problem in many distributed systems. The C4.2 is conservatively rated to handle 80 watts of continuous power equal to or greater than most other brands of 8-inch units, so its continuous SPL output will be more than adequate. Moreover, its low-frequency output can easily be augmented with the addition of the C10.1 subwoofer. For these reasons, the C4.2 represents a great way for you to provide good audio coverage while maintaining a competitive edge in price quotes in installa-



tions that do not need the extended performance of the larger models.

## Reverberant Rooms and High Ceilings

Situations arise, however, in which controlled coverage is more desirable than broad dispersion. Very large live spaces such as gymnasiums, convention centers, shopping mall atriums, and the like all benefit from more controlled sound projection. In such installations, the EVID 8.2HC is the best choice. Its 75-degree coverage pattern above 1kHz provides more intelligibility in large, acoustically live spaces. It also has a high 93dB sensitivity rating for optimum efficiency.

### SPL Requirements: How Loud?

The EVID C8.2 is a great speaker to use when higher SPL is required. The fidelity and bandwidth of the unit is substantial and is ideal for applications requiring high quality foreground music reproduction. The C8.2 has substantial low frequency energy down below 60Hz. This is more than sufficient for most applications.

### Layout: How Many?

The chart below shows the effective coverage diameter of the EVID models assuming a 4-foot listening plane height. Using these figures you can lay out a coverage pattern for the job after deciding the overlap criteria described earlier on page 10.

### Coverage Diameter by Ceiling Height

Model	8'	12'	20'	24'
C4.2	17'	34'	68'	85'
C8.2	11.5'	23'	45'	57'
C8.2HC	6.5'	12'	24'	30'
C10.1	180° coverage			

## Use of Subwoofers

The C10.1 subwoofer can add considerable low-frequency performance to any EVID installation. It is important to note that the C10.1 subwoofer depends on the ceiling and walls to properly load itself and to reinforce its bass output. Correct positioning is important to get maximum impact.

In smaller rooms when a single C10.1 is used, a center or near-center position is best. This gives the most even coverage. For larger rooms where more than one C10.1 are employed, the added effect of the room's walls can be used. In such a space, position the subwoofers evenly throughout the room and a few feet from the wall or corners. The added loading of the walls will enhance the response in these larger areas.

## Troubleshooting Table

<b>Problem</b>	<b>Possible Causes</b>	<b>Action</b>
<b>No output</b>	Amplifier	<p>Make sure the amplifier channel is being fed an input signal (preferably via a “signal input” indicator on the amp).</p> <p>Check that the amplifier channel’s volume is turned up.</p> <p>Connect the speaker and cable, which had no output to another amplifier channel, making sure an input signal is fed to the new amp channel. If you then get output, the problem was the amplifier channel. If not, then the problem may be in the cable or speaker.</p>
	Speaker cable(s)	Replace the cable(s) connecting the loudspeaker system and amplifier.
<b>Questionable or intermittent output such as crackling</b>	Faulty connection	Check all cabling for proper connector contact. A bad connection can result in intermittent contact or dramatically increased resistance, which in turn can cause reduced output or noises unrelated to the signal.
	Improper power tap setting	Check the power tap setting under the speaker grille to ensure the setting is appropriate for the installation and amplifier chosen.
<b>Constant noise such as buzzing, hissing, or humming</b>	A faulty electronic device in the signal chain	Since loudspeakers cannot generate these sounds by themselves, you may have a faulty electronic device in the signal chain.
	Poor system grounding	Check and correct the system grounding, as required.
<b>Poor low-frequency output</b>	Out-of-polarity hookup between multiple speakers	<p>When two speakers are hooked up out of polarity (out of phase), the low frequencies cancel each other out. Try reversing the polarity of one of the speakers either by turning around a dual-banana plug at the amplifier or by reversing the tip/sleeve leads on the jack.</p> <p>Whichever condition results in greater low-frequency output is the in-polarity condition.</p>

If none of the suggestions below solves your problem, contact your nearest EV® service center or EV distributor.



## Uniform Limited Warranty

Electro-Voice® speakers and speaker systems are guaranteed against malfunction due to defects in materials or workmanship for a period of five (5) years from the date of original purchase. The Limited Warranty does not apply to burned voice coils or malfunctions such as cone and/or coil damage resulting from improperly mounted or installed enclosures. If a covered malfunction occurs during the warranty period, the product will be repaired or replaced (at our discretion) without charge. The product will be returned to the customer prepaid. Additional details are included in the Uniform Limited Warranty statement.

## Exclusions and Limitations

The Limited Warranty does not apply to: (a) exterior finish or appearance; (b) certain specific items described in the individual product-line statements below, or in the individual product sheet or owner's manual; (c) malfunction resulting from use or operation of the product other than as specified in the product data sheet or owner's manual; (d) malfunction resulting from misuse or abuse of the product; or (e) malfunction occurring at any time after repairs have been made to the product by anyone other than Electro-Voice® Service or any of its authorized representatives.

## Obtaining Warranty Service

To obtain warranty service, a customer must deliver the product, prepaid, to Electro-Voice® Service or to any of its authorized service representatives, together with proof of purchase of the product in the form of a bill of sale or receipted invoice. A list of authorized service representatives is available from Electro-Voice® Service at 12000 Portland Avenue, Burnsville, MN 55337. Ph: (877) 863-4166.

## Incidental and Consequential Damages Excluded

Product repair or replacement and return to the customer are the only remedies provided to the customer. Electro-Voice® shall not be liable for any incidental or consequential damages including, without limitation, injury to persons or property or loss of use. Some states do not allow the exclusion or limitation of incidental or consequential damages, so the above limitation or exclusion may not apply to you.

## Other Rights

This warranty gives you specific legal rights, and you may also have other rights which vary from state to state.

## Maintenance

No maintenance is required when installed in accordance with installation and wiring guidelines described in this manual.

Specification	EVID C4.2	EVID C8.2	EVID C8.2LP	EVID C8.2HC	EVID C10.1
<b>Dimensions</b> (depth x diam.)	6.9" x 7.1" (176 x 181 mm)	10.0" x 10.6" (255 x 270 mm)	7.0" x 10.6" (190 x 255 mm)	11.9" x 12.6" (303 x 320 mm)	11.9" x 12.6" (303 x 320 mm)
<b>Bezel diameter</b>	8.3" (210 mm)	11.8" (300 mm)	11.8" (300 mm)	13.8" (350 mm)	13.8" (350 mm)
<b>Weight</b>	6 lbs (2.7 kg)	11 lbs (5.0 kg)	11 lbs (5.0 kg)	13.2 lbs (6.0 kg)	15.5 lbs (7.0 kg)
<b>Cabinet construction</b>	Steel enclosure and UL94V-0 rated baffle and bezel	Steel enclosure and UL94V-0 rated baffle and bezel	Steel enclosure and UL94V-0 rated baffle and bezel	Steel enclosure and UL94V-0 rated baffle and bezel	Steel enclosure and UL94V-0 rated baffle and bezel
<b>LF transducer</b>	4" (100 mm) high-compliance driver (weatherized cone)	8" (205 mm) high-compliance driver (weatherized cone)	8" (205 mm) high-compliance driver (weatherized cone)	8" (205 mm) high-compliance driver (weatherized cone)	10" (260 mm) high-compliance driver (weatherized cone)
<b>HF transducer</b>	.75" (19 mm) Ti-coated dome	1" (25 mm) Ti-coated dome	1" (25 mm) Ti-coated dome	1" (25 mm) Ti-coated dome	N/A
<b>Mounting system</b>	Integrated 3-point toggle anchors	Integrated 4-point toggle anchors	Integrated 4-point toggle anchors	Integrated 4-point toggle anchors	Integrated 4-point toggle anchors
<b>Available colors</b>	White (paintable surface)	White (paintable surface)	White (paintable surface)	White (paintable surface)	White (paintable surface)
<b>Grille construction</b>	Powder-coated steel	Powder-coated steel	Powder-coated steel	Powder-coated steel	Powder-coated steel
<b>Acoustic design</b>	Ported cabinet, two-way design, internally damped, w/passive crossover	Ported cabinet, two-way design, internally damped, w/passive crossover	Ported cabinet, two-way design, internally damped, w/passive crossover	Ported cabinet, waveguide-coupled, two-way design, internally damped w/passive crossover	Ported cabinet, internally damped w/passive crossover





Specification	EVID C4.2	EVID C8.2	EVID C8.2LP	EVID C8.2HC	EVID C10.1
<b>Frequency response</b>	65 Hz–20 kHz	50 Hz–20 kHz	50 Hz–20 kHz	50 Hz–20 kHz	45 Hz–150 Hz
<b>Power handling (@ 8Ω)</b>	50 W (with overload protection)	75 W (with overload protection)	75 W (with overload protection)	75 W (with overload protection)	100 W (with overload protection)
<b>Coverage pattern</b>	130° conical	110° conical	110° conical	75° conical	N/A
<b>Sensitivity (SPL 1 W/1 m)</b>	86 dB	91 dB	91 dB	93 dB	94 dB
<b>Input configuration</b>	8Ω; 70V/100V	8Ω; 70V/100V	8Ω; 70V/100V	8Ω; 70V/100V	8Ω; 70V/100V
<b>70V/100V power taps</b>	1.8 (70V only)/ 3.7/7.5/15/30W	1.8 (70V only)/ 3.7/7.5/15/30W	1.8 (70V only)/ 3.7/7.5/15/30W	7.5 (70V only)/ 15/30/60 W	7.5 (70V only)/ 15/30/60 W
<b>Included accessories</b>	Tile bridge, mounting ring	Tile bridge, mounting ring	Tile bridge, mounting ring	Tile bridge, mounting ring	Tile bridge, mounting ring

# Notes



**America**

USA: Telex Communications Inc. 12000 Portland Ave South, Burnsville, MN 55337, USA, Phone: 952-884-4051, Fax: 952-884-0043  
Canada (East): Acoustik GE Inc. 5715 Kincoourt, Montréal, PO H4W 1Y7, Canada, Phone: 866-369-2864, 514-369-2864, Fax: 514-487-9525  
Canada (Ontario): HEK Marketing Inc. 27 Fearn Crescent, Ajax, ON L1S 5L7, Canada, Phone: 800-494 6770, Fax 905-619-0366  
Canada (West): KMT Pro Audio. 04-301 Nassau Street North, Winnipeg, MB R3L-2J5, Canada, Phone: 888-850-8811, Fax: 204-489-7614  
Mexico: Telex de Mexico S.A. de C.V., Av. Parque Chapultepec 66-202, Col. El Parque, Edo. de Mexico, Phone:+52 (55) 5358-5434, Fax:+52 (55) 5358-5588  
Latin America: Telex Communications Inc. 12000 Portland Ave South, Burnsville, MN 55337, USA, Phone: 952-887-5532, Fax: 952-736-4212

**Europe, Africa & Middle-East**

Germany: Telex EVI Audio GmbH. Hirschberger Ring 45, D 94315, Straubing, Germany, Phone: +49 9421-706 0, Fax: +49 9421-706 265  
France: EVI Audio France S.A. Parc de Courcerin, Allée Lech Walesa, F 77185 Lognes, France, Phone: +33 1-6480-0090, Fax: +33 1-6006-5103  
UK: Telex Communications Ltd. 4, The Willows Centre, Willow Lane, Mitcham, Surrey CR4 4NX, UK, Phone: +44 208 646 7114, Fax: +44 208 640 7583  
Africa & Middle-East: Telex EVI Audio GmbH. Hirschberger Ring 45, D 94315, Straubing, Germany, Phone: +49 9421-706 0, Fax: +49 9421-706 265

**Asia & Pacific Rim**

Japan: EVI Audio Japan Ltd. 5-3-8 Funabashi, Setagaya-Ku, Tokyo, Japan 156-0055, Phone: +81 3-5316-5020, Fax: +81 3-5316-5031  
Australia: EVI Audio (Aust) Pty Ltd. Slough Business Estate, Unit 23, Silverwater, N.S.W. 2128, Australia, Phone: +61 2-9648-3455, Fax: +61 2-9648-5585  
China: EVI Audio (HK) Ltd. 7th Floor China Minmetals Tower, No. 79 Chatham Road South, Tsim Sha Tsui, Kowloon, HK, Phone: +852 2351-3628, Fax: +852 2351-3329  
Singapore: Telex Pte. Ltd. 3015A Ubi Road 1, 05-10 Kampong Ubi Industrial Estate, Singapore 408705, Phone: +65 6746-8760, Fax: +65 6746-1206

**www.electrovoice.com • Telex Communications, Inc. • www.telex.com**

© Telex Communications, Inc. 07/2003

Part Number 38110-143

Rev. C — 7.8.2003